

DBS – 08 – 01

Open Macroeconomies as
A Closed Economic System
– SD Macroeconomic Modeling Completed –

Kaoru Yamaguchi *

Doshisha Business School
Doshisha University
Kyoto 602-8580, Japan

E-mail: kaoyamag@mail.doshisha.ac.jp

Abstract

This paper completes the series of macroeconomic modeling that tries to model macroeconomic dynamics on the basis of the principle of accounting system dynamics developed by the author. Money supply and creation processes of deposits were modeled in the first paper, while the second paper built dynamic determination processes of GDP, interest rate and price level. In the third paper, these two separate models were integrated to present a complete macroeconomic dynamic model consisting of real and monetary sectors. The fourth paper presented a model of a dynamic determination of foreign exchange rate in an open macroeconomy in which goods and services are freely traded and financial capital flows efficiently for higher returns. This fifth and final paper in the series tries to expand the integrated model in the third paper to the open macroeconomies according to the framework developed in the fourth paper. It provides a complete generic model of open macroeconomies as a closed system, consisting of two economies, a foreign economy as an image of domestic economy. As a demonstration of its analytical capability, a case of credit crunch is examined to show how domestic macroeconomic behaviors influence foreign macroeconomy through trade and financial capital flows.

1 Open Macroeconomic System Overview

This is the fifth and final paper of a series of macroeconomic modeling that tries to model macroeconomic dynamics on the basis of the principle of accounting

*This paper is submitted to the 26th International Conference of the System Dynamics Society, Athens, Greece, July 23-27, 2008. It is partly supported by the grant awarded by the Japan Society for the Promotion of Science.

system dynamics developed by the author in [3]. In the first paper [4], money supply and creation processes of deposits were modeled. In the second paper [5], dynamic determination processes of GDP, interest rate and price level were modeled. For this analysis four sectors of macroeconomy were introduced such as producers, consumers, banks and government. The third paper [6] integrated real and monetary sectors that had been analyzed separately in the previous two papers; in other words, by adding central bank, five sectors of the macroeconomy were fully integrated together with a labor market. The fourth paper [7] built a model of a dynamic determination of foreign exchange rate in open macroeconomies in which goods and services are freely traded and financial capital flows efficiently for higher returns. For this purpose a new method was needed contrary to a standard method of dealing with a foreign sector as adjunct to macroeconomy; that is, an introduction of another macroeconomy as a foreign sector as illustrated in Figure 1.

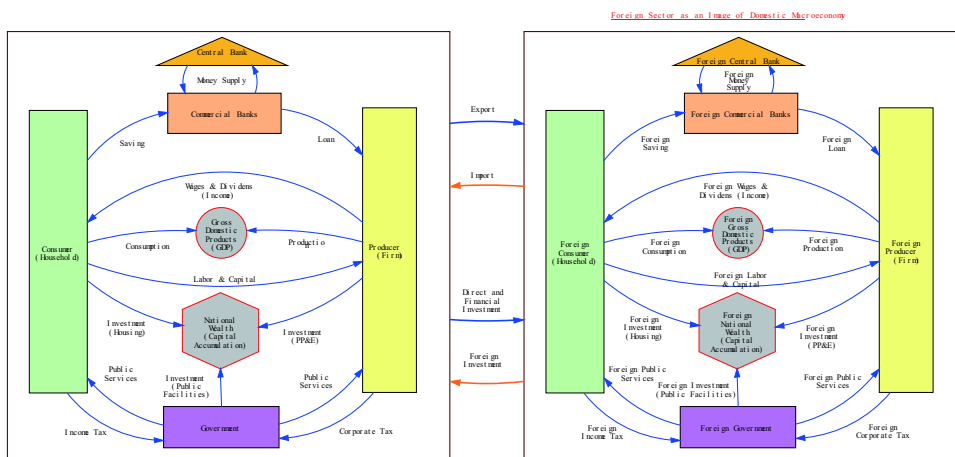

Figure 1: Open Macroeconomic System Overview

In this paper, the integrated macroeconomy in the third paper is opened to foreign economy through trade and financial capital flows according to the framework developed in the fourth paper. In other words, a complete mirror economy is created as a foreign economy except for banking sectors such as commercial and central banks. Specifically, it is assumed that all foreign exchange transactions are done through domestic banks to meet the demand for foreign exchange services by consumers and producers. To make our model a little bit more realistic, Japanese yen is used as a unit of domestic currency from now on, and dollar is used as a key currency of international trade issued by a foreign country, say, the United States.

2 The Integrated Model Revisited

Before expanding the integrated economy in the third paper to an open economy, we have revisited the previous integrated model and found that some revisions to it are required as stated below.

Wage Rate Adjustment

In the integrated model, a dynamic mechanism of wage rate determination was not considered. Nominal wage rate is now assumed to be determined in the labor market as follows:

$$\frac{dw}{dt} = \phi(L^* - L^s) \quad (1)$$

where L^* denotes demand for desired labor, while L^s indicates supply of labor forces. Labor demand and net employment is in return determined by a real wage rate such that $R = w/P$. Whenever labor market becomes tight and unemployment rate approaches to zero, an expected wage rate w^e , as a function of wage rate w and inflation rate, will increase, causing desired demand for labor to decrease. It decreases as the unemployment rate increases, causing the desired demand for labor to increase. These changes are reflected in Figure 18 below.

Price Adjustment by Cost-push Force

In the integrated model, price is assumed to be adjusted by the demand-pull forces generated by a discrepancy between desired aggregate demand and full capacity output such that

$$\frac{dP}{dt} = \Psi(Y^D - Y_{full}). \quad (2)$$

With the introduction of wage determination in equation (1), it now becomes possible to add cost-push forces to the price adjustment process. These forces are represented by a change in the nominal wage rate such that

$$w_g = \frac{d \log(w)}{dt} \quad (3)$$

The price adjustment process is now influenced by demand-pull and cost-push forces as well such that

$$\frac{dP}{dt} = \Psi_1(Y^D - Y_{full}) + \Psi_2(w_g) \quad (4)$$

These changes are reflected in Figure 18 below.

Investment Order Placement and Delay

To reflect the fact that investment process takes time, a capital stock under construction is newly added to the capital accumulation process. That is, new investment is accumulated to the capital stock under construction, out of which capital stock (property, plant & equipment) is accumulated after a completion of capital under construction. This revision is illustrated in Figure 17.

Credit Loans by the Central Bank

In the integrated model, banks are assumed to make loans to producers as much as desired. This unlimited loans by banks caused their vault cash to be negative, and eventually could have forced them to go bankrupt unless they could raise additional fund. This serious flaw of the model was utterly overlooked in our previous analysis.

It turned out that banks are persistently in a state of shortage of cash as well as producers. This point is neglected in many textbooks. In the case of producers, they could borrow enough fund from banks. From whom, then, should the banks borrow in case of cash shortage? In a closed economic system, money or currency has to be created within the system. Only the central bank is endowed with a power to create currency within the system, and make loans to the commercial banks as a last resort of currency provider to avoid bankruptcies of the whole economic system. This process of lending money by creating (or printing) currency is known as *money out of nothing*.

Figure 2 indicates unconditional amount of annual loans and its growth rate by the central bank at the request of desired borrowing by banks. In other words, currency has to be incessantly created and put into circulation in order to sustain an economic growth under mostly equilibrium states. Roughly speaking, a growth rate of credit creation has to be in average equal to or slightly greater than the economic growth rate as suggested by the right hand diagram of Figure 2.

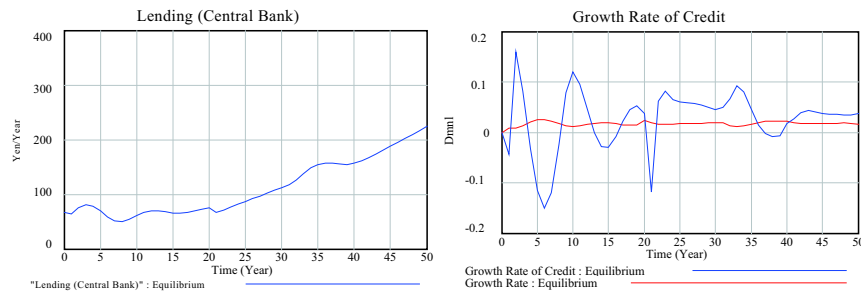

Figure 2: Lending by the Central Bank and its Growth Rate

In this way, the central bank begins to exert an enormous power over the economy through credit control. What happens if the central bank fails to

supply enough currency intentionally or unintentionally? An influential role of the central bank which caused economic bubbles and the following burst in Japan during 90's is completely analyzed by Warner in [1]. Our revised macroeconomic model might give an analytical foundation to support his new findings in the role of the central bank.

Four Types of Interest Rates

With the introduction of credit loan by the central bank, another type of interest rate needs to be applied to the transaction, which is called discount rate. The central bank is given a power to set its rate as a part of its monetary policies whenever making loans to commercial banks. It is set to be 0.8%, or 0.008 in our model.

Now the economy has four different types of interest rates; discount rate, real rate of interest, nominal rate of interest, and prime rate. How are they related one another? It is assumed that the initial value of the real rate of interest (which is set to be 0.02 in our model) is increased by the amount of discount rate such that

$$\text{Initial value} = \text{initial interest rate} + \text{discount rate} \quad (5)$$

Nominal rate of interest and prime rate are assumed to be determined in our previous models as

$$\text{Interest rate (nominal)} = \text{real interest rate} + \text{inflation rate} \quad (6)$$

and

$$\text{Prime rate} = \text{interest rate (nominal)} + \text{prime rate premium}, \quad (7)$$

where prime rate premium is set to be 0.03 in our model to attain positive profits to the banks. Accordingly, discount rate affect all of the other three types of interest rate, giving a legitimacy of monetary policies to the central bank.

3 Behaviors of the Revisited Model

Mostly Equilibria

An equilibrium state has been defined as *a full capacity aggregate demand equilibrium* if the following three output and demand levels are met:

$$\text{Full Capacity GDP} = \text{Desired Output} = \text{Aggregate Demand} \quad (8)$$

If the economy is not in the equilibrium state, then, actual GDP is determined by

$$\text{GDP} = \text{MIN} (\text{Full Capacity GDP}, \text{Desired Output}) \quad (9)$$

In other words, if desired output is greater than full capacity GDP, then actual GDP is constrained by the production capacity, meanwhile in the opposite case,

GDP is determined by the amount of desired output which producers wish to produce, leaving the capacity idle.

Even though full capacity GDP is attained, full employment may not be realized unless

$$\text{Potential GDP} = \text{Full Capacity GDP} \quad (10)$$

Does the equilibrium state, then, exist in the sense of full capacity GDP and full employment? By trial and error, mostly equilibrium states are acquired in the revisited model whenever price is flexibly adjusted by setting its coefficient to be 0.5, as illustrated in Figure 3.

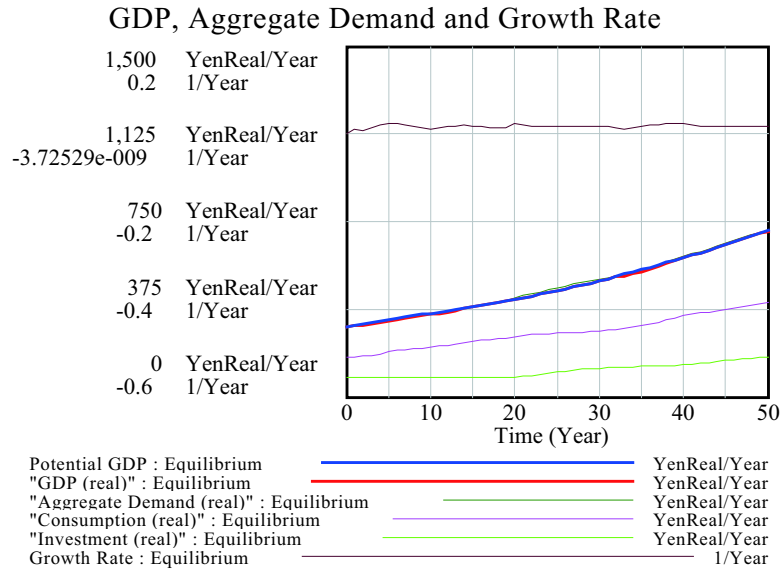

Figure 3: Mostly Equilibrium States

In what follows, these equilibrium states are used as a benchmarking state of the comparison, and illustrated by red lines in Figures.

Fixprice Disequilibria

We are now in a position to make some analytical simulations for the revisited model before opening it to the foreign economy. First, let us show that without price flexibility it's hard to attain mostly equilibrium states. When price is fixed; that is, price coefficient is set to be zero, disequilibria begin to appear all over the period. Figure 4 illustrates how fixprice causes disequilibria everywhere. The economy seems to stagger; that is, GDP stops growing and economic growth rate becomes closer to zero.

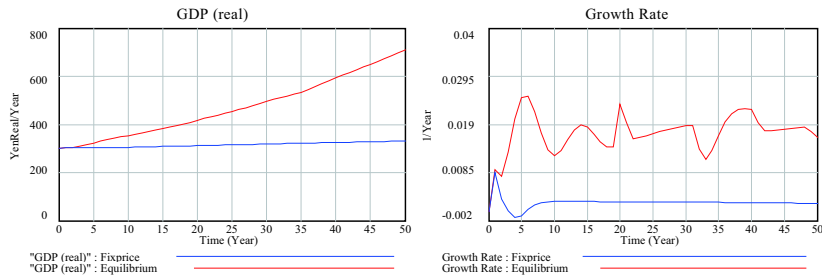

Figure 4: Fixprice and Mostly Equilibrium States

Business Cycles by Inventory Coverage

In the third paper business cycles are shown to be triggered by inventory coverage and price fluctuation. Let us first examine if similar business cycles arise when producers decide to keep some amount of inventory. Specifically, suppose the normal inventory coverage is now set to be 0.25 or 3 months instead of no inventory coverage. The economy, then, begins to be troubled with a short period of business cycle as Figure 5 portrays.

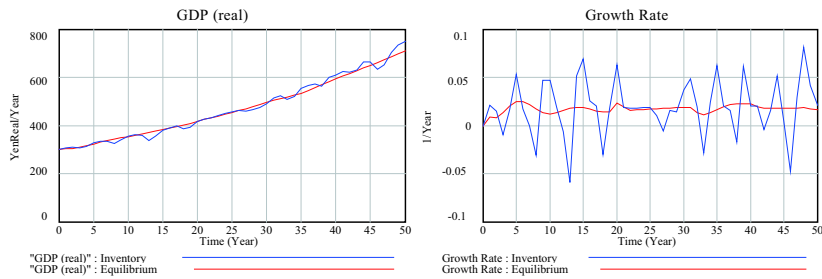

Figure 5: Business Cycles by Inventory Coverage

Business Cycles by Price Fluctuation

Next let us see if business cycles surface when price begins to fluctuate more fiercely. Since price adjustment process is revised in equation (4), let us assume that this time price is affected by the cost-push changes in nominal wage rate. Specifically, cost-push(wage) coefficient is set to be 0.5 from 0. Again, the economy is thrown into business cycle as depicted in Figure 6.

Economic Recession by Credit Crunch

With the introduction of credit loans to banks, the central bank seems to have acquired an almighty power to control credit. This power has been overlooked

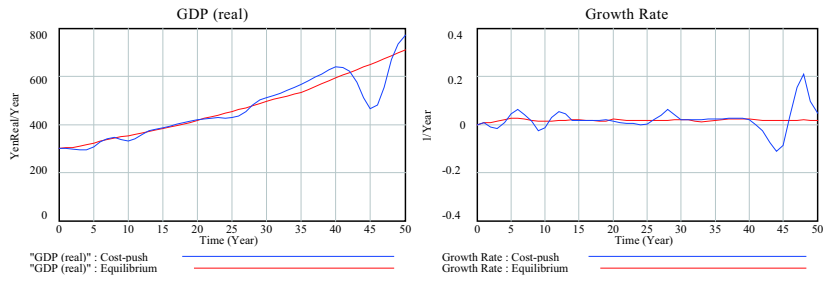

Figure 6: Business Cycles by Cost-push Price Fluctuation

in our previous analysis, as it is not well explained in standard textbooks. This hidden exerting power has been known in Japan as “window guidance”.

To demonstrate how influential the power is, let us suppose that the central bank reduces the amount of credit loans by 30%; that is, window guidance value is reduced to 0.7 from 1. In other words, banks can borrow only 70% of the desired amount of borrowing from the central bank.

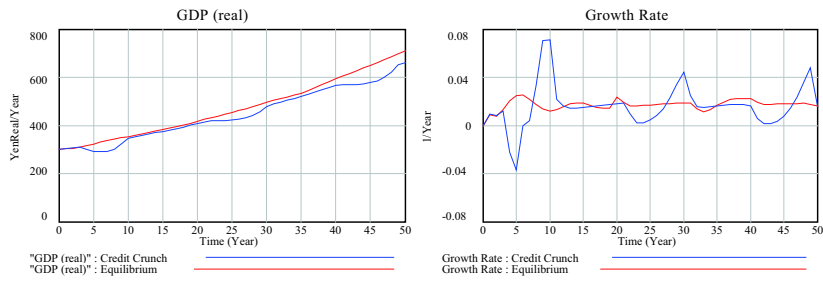

Figure 7: Economic Recession by Credit Crunch

Figure 7 illustrates the economy is now deeply triggered into recession in the sense that the GDP under credit crunch is always below the equilibrium GDP. It is unexpected to see that the economic recession is provoked by the credit crunch rather than the business cycles as shown above. Economic recessions caused by the credit crunch can be said to be worse than the recessions caused by other business cycles.

As discussed above, growing economy needs new currencies to be incessantly put into circulation. If the central bank, instead of the government, is historically endowed with this important role, savvy control of credits by the central bank becomes crucial for the stability and growth of macroeconomy as demonstrated here by our revisited model.

4 Open Macroeconomies (Transactions)

We are now in a position to open our integrated macroeconomy to foreign trade and direct and financial investment abroad. According to our method in the fourth paper, this is nothing but a process of creating another macroeconomy as an image economy of domestic macroeconomy. All variables of the foreign economy, then, are renamed with a suffix of .f; for instance, GDP.f, consumption.f, etc.

To avoid analytical complication, we have picked up the existing currency units of yen and dollar, among which dollar is assumed to play a role of key currency. We have further assumed that a domestic economy has yen currency, and a foreign economy has dollar currency.

Nominal foreign exchange rate FE (merely called foreign exchange rate here) is now the amount of yen in exchange for one unit of foreign currency; that is, dollar as assumed above, and has a unit of *Yen/Dollar*. At this stage of building a generic open macroeconomy, initial foreign exchange rate is set to be one; that is, one yen is exchanged for one dollar. Foreign exchange rate thus defined does not absolutely reflect that of the current exchange rate in a real world economy.

Real foreign exchange rate (RFE) is the amount of real goods worth per unit of the equivalent foreign real goods such that

$$RFE = \frac{FE * P_f}{P} \quad (11)$$

which has a unit of *YenReal/DollarReal*.

Let us now describe main transactions of the open macroeconomy by producers, consumers, government, banks and the central bank.

Producers

Main transactions of producers are summarized as follows. They are also illustrated in Figure 19 in which stocks of gray color are newly added for open economies.

- Out of the GDP revenues producers pay excise tax, deduct the amount of depreciation, and pay wages to workers (consumers) and interests to the banks. The remaining revenues become profits before tax.
- They pay corporate tax to the government out of the profits before tax.
- The remaining profits after tax are paid to the owners (that is, consumers) as dividends, including dividends abroad. However, a small portion of profits is allowed to be held as retained earnings.
- Producers are thus constantly in a state of cash flow deficits. To make new investment, therefore, they have to borrow money from banks and pay interest to the banks.

- Producers imports goods and services according to their economic activities, the amount of which is assumed to be 10% of GDP in our model, though actual imports are also assumed to be affected by their demand curves.
- Similarly, their exports are determined by the economic activities of a foreign economy, the amount of which is also assumed to be 10% of foreign GDP.
- Producers are also allowed to make direct investment abroad as a portion of their investment, 10% is assumed in our model. Investment income from these investment abroad are paid by foreign producers as dividends directly to consumers as owners of assets abroad. Meanwhile, producers are required to pay foreign investment income (returns) as dividends to foreign investors (consumers) according to their foreign financial liabilities.
- Foreign producers are assumed to behave in a similar fashion as a mirror image of domestic producers

Consumers

Main transactions of consumers are summarized as follows. They are also illustrated in Figure 20 in which stocks of gray color are newly added for open economies.

- Sources of consumers' income are their labor supply, financial assets they hold such as bank deposits, shares (including direct assets abroad), and deposits abroad. Hence, consumers receive wages and dividends from producers, interest from banks and government, and direct and financial investment income from abroad.
- Financial assets of consumers consist of bank deposits and government securities, against which they receive financial income of interests from banks and government.
- In addition to the income such as wages, interests, and dividends, consumers receive cash whenever previous securities are partly redeemed annually by the government.
- Out of these cash income as a whole, consumers pay income taxes, and the remaining income becomes their disposal income.
- Out of their disposable income, they spend on consumption. The remaining amount is either spent to purchase government securities or saved.
- Consumers are now allowed to make financial investment abroad out of their financial assets consisting of stocks, bonds and cash. For simplicity, however, their financial investment are assumed to be made out of deposits. Hence, returns from financial investment are uniformly evaluated in terms of deposit returns.

- Consumers now receive direct and financial investment income. Similar investment income are paid to foreign investors by producers and banks. The difference between receipt and payment of those investment income is called income balance. When this amount is added to the GDP revenues, GNP (Gross National Product) is calculated. If capital depreciation is further deducted, the remaining amount is called NNP (Net National Product).
- NNP thus obtained is completely paid out to consumers, consisting of workers and shareholders, as wages to workers and dividends to shareholders, including foreign shareholders.
- Foreign consumers are assumed to behave in a similar fashion as a mirror image of domestic consumers.

Government

Transactions of the government are illustrated in Figure 21, some of which are summarized as follows.

- Government receives, as tax revenues, income taxes from consumers and corporate taxes from producers.
- Government spending consists of government expenditures and payments to the consumers for its partial debt redemption and interests against its securities.
- Government expenditures are assumed to be endogenously determined by either the growth-dependent expenditures or tax revenue-dependent expenditures.
- If spending exceeds tax revenues, government has to borrow cash from consumers and banks by newly issuing government securities.
- Foreign government is assumed to behave in a similar fashion as a mirror image of domestic government.

Banks

Main transactions of banks are summarized as follows. They are also illustrated in Figure 22 in which stocks of gray color are newly added for open economies.

- Banks receive deposits from consumers and consumers abroad as foreign investors, against which they pay interests.
- They are obliged to deposit a portion of the deposits as the required reserves with the central bank.
- Out of the remaining deposits, loans are made to producers and banks receive interests for which a prime rate is applied.

- If loanable fund is not enough, banks can borrow from the central bank for which discount rate is applied.
- Their retained earnings thus become interest receipts from producers less interest payment to consumers and to the central bank. Positive earnings will be distributed among bank workers as consumers.
- Banks buy and sell foreign exchange at the request of producers, consumers and the central bank.
- Their foreign exchange are held as bank reserves and evaluated in terms of book value. In other words, foreign exchange reserves are not deposited with foreign banks. Thus net gains realized by the changes in foreign exchange rate become part of their retained earnings (or losses).
- Foreign currency (dollars in our model) is assumed to play a role of *key* currency or *vehicle* currency. Accordingly foreign banks need not set up foreign exchange account. This is a point where a mirror image of open macroeconomic symmetry breaks down.

Central Bank

Main transactions of the central bank are summarized as follows. They are also illustrated in Figure 23 in which stocks of gray color are newly added for open economies.

- The central bank issues currencies against the gold deposited by the public.
- It can also issue currency by accepting government securities through open market operation, specifically by purchasing government securities from the public (consumers) and banks. Moreover, it can issue currency by making credit loans to commercial banks. (These activities are sometimes called *money out of nothing*.)
- It can similarly withdraw currencies by selling government securities to the public (consumers) and banks, and through debt redemption by banks.
- Banks are required by law to reserve a certain amount of deposits with the central bank. By controlling this required reserve ratio, the central bank can control the monetary base directly.
- The central bank can additionally control the amount of money supply through monetary policies such as open market operations and discount rate.
- Another powerful but hidden control method is through its direct influence over the amount of credit loans to banks (known as *window guidance* in Japan.)

- The central bank is allowed to intervene foreign exchange market; that is, it can buy and sell foreign exchange to keep a foreign exchange ratio stable (though this intervention is actually exerted by the Ministry of Finance in Japan, it is regarded as a part of policy by the central bank in our model).
- Foreign exchange reserves held by the central bank is usually reinvested with foreign deposits and foreign government securities, which are, however, not assumed here as inessential.

Missing Loops Fixed

In the fourth paper five loops below are pointed out as missing.

- Imports and exports are assumed to be determined by the economic activities of GDPs, which are in turn affected by the size of trade balance. Yet, they are missing.
- Foreign exchange intervention by the central bank (and the government) such as the purchase or sale of foreign exchange surely changes the amount of currency outstanding and money supply, which in turn must affect an interest rate and a price level. Yet, they are being fixed.
- A change in interest rates affects investment, which in turn determines the level of GDP. Yet, investment is not playing such a role.
- A change in price level must also affect consumption spending and hence real GDP. Yet, these loops are missing.
- Official intervention must influence speculations and estimations on foreign exchange and investment returns among international financial investors. Yet, these fluctuations are only given by outside random normal distribution.

Our open macroeconomies have successfully augmented these missing feedback loops except the last loop of speculation. Figure 8 illustrates newly fixed feedback loops.

5 Behaviors of Open Macroeconomies

Mostly Equilibria under Trade and Capital Flows

The construction of open macroeconomies is now completed. There are three channels to open a domestic economy to a foreign economy. Trade channel is opened by allowing producers to import a portion of its GDP for domestic production and distribution. Capital flows have two channels. First, producers are allowed to make direct investment abroad as a portion of their domestic investment. Secondly, consumers are allowed to make deposits abroad out of their domestic deposits as a financial portfolio investment. (For simplicity, portfolios

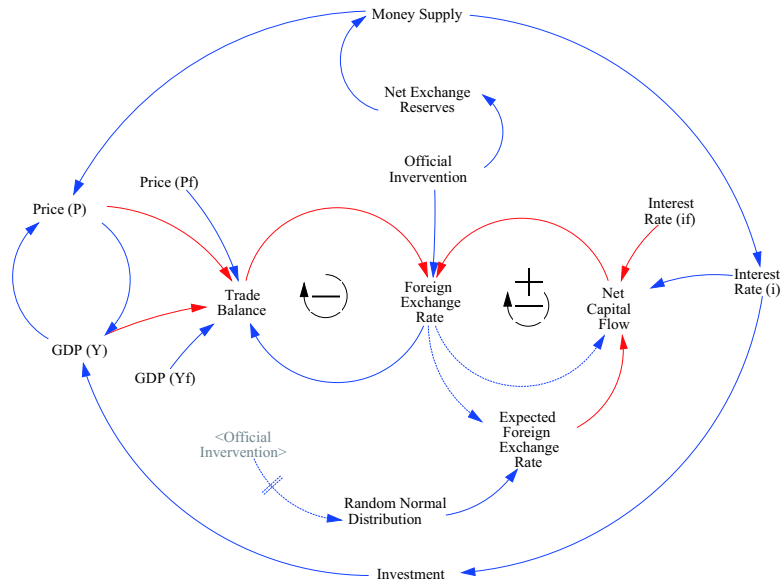

Figure 8: Fixed Missing Loops in the Foreign Exchange Dynamics Model

among deposits, shares and securities are not considered here.) These capital flows by direct and financial investment are determined by the interest arbitrage as analyzed in the fourth paper.

Let us now open all three channels by setting the values of import coefficient, direct investment ratio, and financial investment ratio to be the same 10%, respectively. Under the international activities of such trade and capital flows, Figure 9 demonstrates that our open macroeconomies can attain mostly equilibrium states.

Mostly equilibrium states thus obtained, however, do not imply balances of trade and capital flows. In fact, a small amount of trade imbalance is still observed as illustrated in Figure 10. Moreover, alternating interest arbitrages generate small amounts of capital inflows and outflows as illustrated in Figure 11 due to the different interest rates prevailing over two economies, and random normal distribution that is exerted on the expected foreign exchange rate.

Credit Crunch under Trade and Capital Flows

Our generic model of open macroeconomies could be applied in many different ways for the economic analyses of specific issues. In the above section of the revisited macroeconomic behaviors, two types of business cycles and economic recession are triggered out of the mostly equilibrium states. It would be interesting, as a continuation of our discussions, to examine how these domestic business cycles and recession affect foreign macroeconomies through trade and capital flows.

GDP, Aggregate Demand and Growth Rate

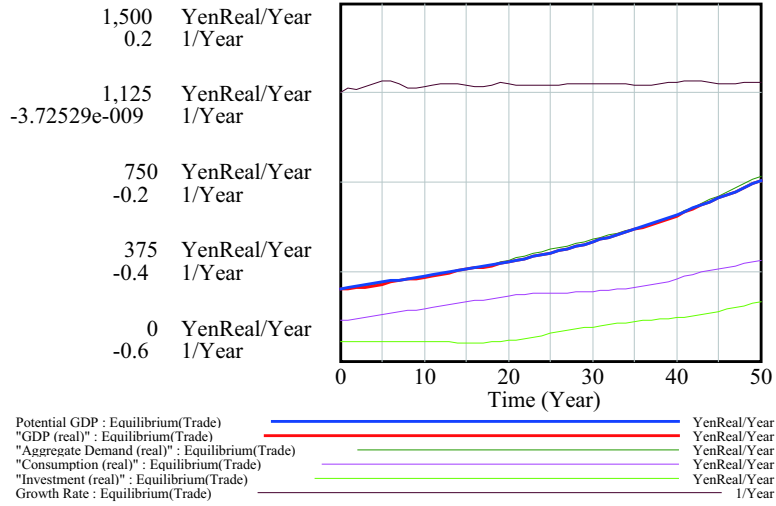

Figure 9: Mostly Equilibria under Trade and Capital Flows

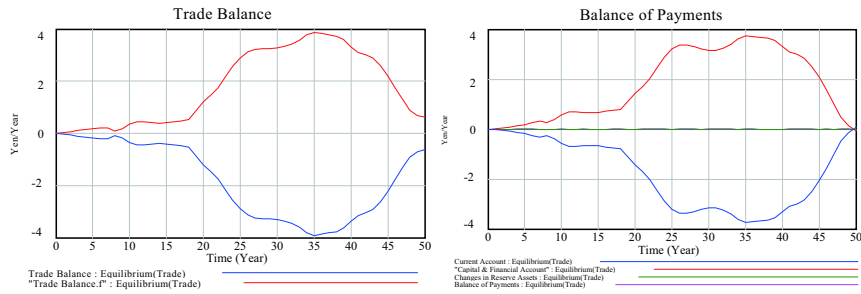

Figure 10: Trade Balance and Balance of Payments

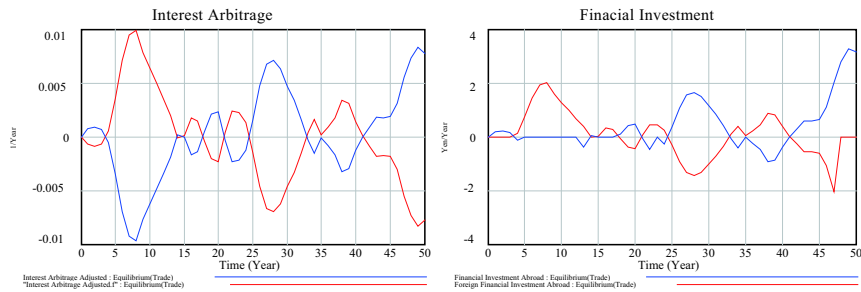

Figure 11: Interest Arbitrage and Financial Investment

Due to a limited space of the paper, our analysis is confined only to the economic recession triggered by the credit crunch. For this purpose, let us now assume that the central bank reduces the amount of credit loans by 40%, instead of 30% in the above case. As already demonstrated above, an economic recession is similarly generated again in the domestic economy as illustrated in Figure 12. (Compare this with Figure 7 above.)

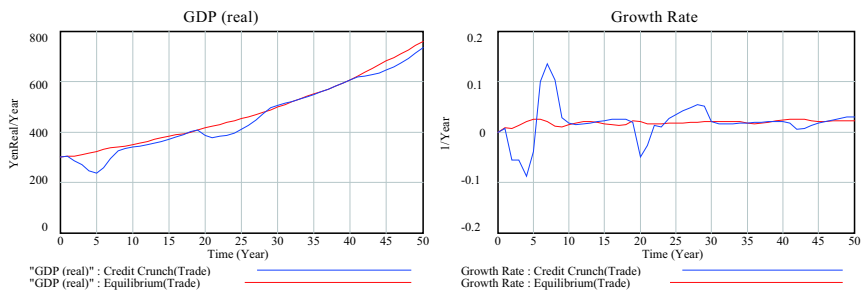

Figure 12: Credit Crunch under Trade and Capital Flow

Does this domestic recession affect the foreign economy? Figure 13 illustrates the foreign country's GDP and its growth rate. It clearly displays that economic recession is being exported to the foreign economy through trade and capital flows. This means vice versa that our domestic economy cannot be also free from the influence of foreign economic behaviors. In this sense, open macroeconomies can be said to be mutually interdependent and constitute indeed a closed economic system as a whole.

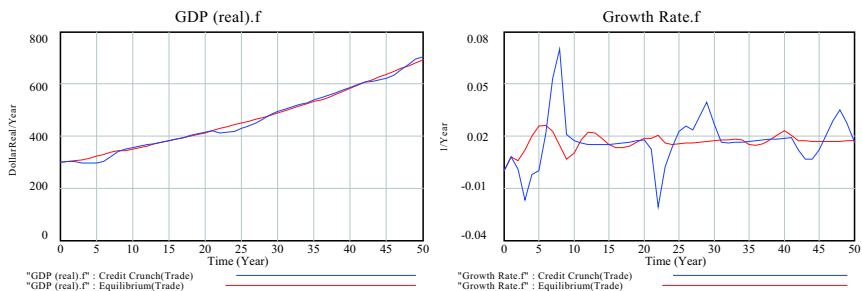

Figure 13: Credit Crunch Affecting Foreign Macroeconomy

6 Where to Go from Here?

Robust Foundation of the Model

Our macroeconomic model building is based on the following two well-established scientific methods;

- Double-entry accounting system: foundation of social science
- Theory of differential equations: foundation of natural science

Accounting system has been said to be the most rigorous methodology in social science, and widely used since the ancient days to keep orderly records of chaotic market transactions. Differential equations have been, since Newton, widely applied to describe dynamic movements in natural science, and have been the most fundamental tool for dynamical analysis. System dynamics is in a sense a computer-based tool for the numerical analysis of differential equations.

These two well-established scientific methods are consolidated as the method of accounting system dynamics [3], and have been applied in our model building of macroeconomic system. Hence, our model could be said to have been built on the robust foundation, and in this sense may provide a generic framework for further analysis in macroeconomic theory. Where should we go from here then? At least three roads seem to lie ahead of us.

Road 1: Unified Macroeconomic Systems View

By its nature as a generic model, our model could be refined to clarify the fundamental causes of disputes among different schools of economic thoughts; for instance, in the line of unification among Neoclassical, Keynesian and Marxian schools in [2]. It is our belief that their differences are those of the assumptions made in the model, not the framework of the model itself. If this is right, the model could provide a common framework for further theoretical discussions among economists. Accordingly, depending on the economic issues for clarification the model could be fine-tuned for sharing various economic views.

Following are some of these fine-tuning directions for further analysis of the economic issues if they are the focus of macroeconomic controversies.

1. Portfolio decisions for financial assets and wealth among cash, shares and securities are not yet incorporated.
2. Housing investment and real estate transactions by consumers are not treated.
3. Consumption is a function of basic consumption C_0 , income Y and Price P , but interest i and wealth effect W_e are still not considered such that

$$C = C(C_0, Y, P, i, W_e) \quad (12)$$

4. An interdependent relation between money supply and inflation is weak, and only the following causal route is covered; Money(\uparrow) \longrightarrow Investment(\uparrow) \longrightarrow Desired Output(\uparrow) \longrightarrow Price(\uparrow).
Moreover, inflation in financial assets and real estate is not treated.
5. Proportionate movement of price and wages is weak.
6. Comparative advantage theory of international trade is not handled.

Road 2: Japanese and US Macroeconomic Modeling

The series of macroeconomic modeling was originally intended to construct a Japanese macroeconomic model for strategic applications among business executives and policy makers. And we still believe it's the road we should take as a next step. Specifically, we'd like to analyze the world largest and second largest economies in terms of GDP simultaneously; that is, Japanese macroeconomy as a domestic economy and US macroeconomy as a foreign economy along the framework of our open macroeconomies.

For this purpose, then, actual macroeconomic data have to be incorporated into the model. It would be very interesting to see, out of many possible behaviors the model can produce like chaos out of a simple deterministic equation, which possibility is to be chosen historically by the real economy.

Road 3: Systems of National Account

Our modeling method turns out to be along the United Nations *System of National Accounts 1993*, known as 'the SNA93', though in a more wholistic way. Accordingly, it could be extended closer to the complete SNA93 in a systemic way.

7 Conclusion

This is the fifth and final paper that completes the series of building macroeconomic system. The integrated macroeconomic model developed in the third paper is firstly revisited to make several revisions. One new addition to the model is the credit creation process of the central bank. And it is newly shown that credit crunch triggers economic recession in addition to the previously analyzed business cycles caused by inventory coverage and price fluctuation.

The revisited model is, then, extended to the open macroeconomies on the basis of the balance of payment in the fourth paper. Its main feature is that two similar macroeconomies are needed to analyze international trade and capital flows through direct and financial investment.

With a completion of building the open macroeconomies, many possibilities are made available for the analysis of economic issues. Due to the limited space, our analysis is confined only to the issue of credit crunch. Then, it is shown that an economic recession triggered by the domestic credit crunch also causes a similar recession in a foreign economy through the transactions of trade and capital flows. In this sense, open macroeconomies are indeed demonstrated to be a closed system in which economic behaviors are reciprocally interrelated.

The idea of modeling macroeconomic system came up while I was visiting the Univ. of California at Berkeley as a visiting scholar for 8 months after the presentation of the paper on the principle of accounting system dynamics at the SD conf. in New York, July, 2003. Since then almost five years have passed for completing the series of SD macroeconomic modeling in this current paper. Though the model is still far from being complete and genetic by its

nature, it's time, I believe, to make it open to the public for further fine-tunings and revisions by the SD peers and macroeconomists as well as those who are interested in our approach.

MacroDynamics Model Illustrated¹

Title	
Overview	
Population Labor Force	Population Labor Force.f
Currency Circulation	Currency Circulation.f
GDP	GDP.f
Interest, Price & Wage	Interest, Price & Wage.f
Producer	Producer.f
Consumer	Consumer.f
Government	Government.f
Banks	Banks.f
Central Bank	Central Bank.f
Foreign Exchange Rate	Balance of Payments
GDP Simulation	GDP Simulation.f
Fiscal Policy	Fiscal Policy.f
Monetary Policy	Monetary Policy.f
Trade & Investment Abroad Simulation	
Economic Indicators	Economic Indicators.f
B/S Check	B/S Check.f

(c) Prof. Kaoru Yamaguchi
Doshisha Business School
Japan

Macroeconomic Dynamics Model

< MacroDynamics 1.0 >

- Accounting System Dynamics Approach -

(c) All Rights Reserved.

Prof. Kaoru Yamaguchi, Ph.D.

Doshisha Business School
Doshisha University
Kyoto, Japan

kaoyamag@mail.doshisha.ac.jp

This model provides a generic system on which various schools of economic thoughts can be built. Your comments and suggestions are most welcome.

Figure 14: Title Page of the MacroDynamics Model

¹In this illustrated section of the model, only domestic macroeconomy is presented. The model called MacroDynamics version 1.0 is now available for educational use through the contact with the author. It runs on the Vensim Model Reader (freeware) which can be downloaded from <http://www.vensim.com>

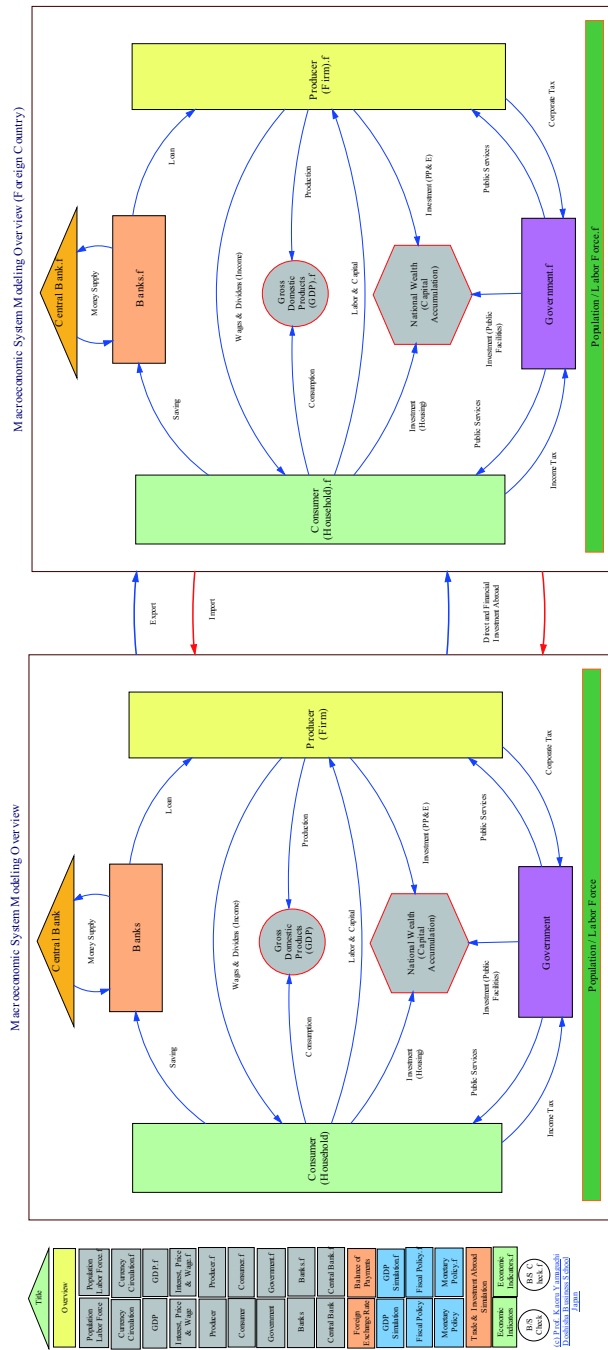

Macroeconomic System Modeling Overview (Foreign Country)

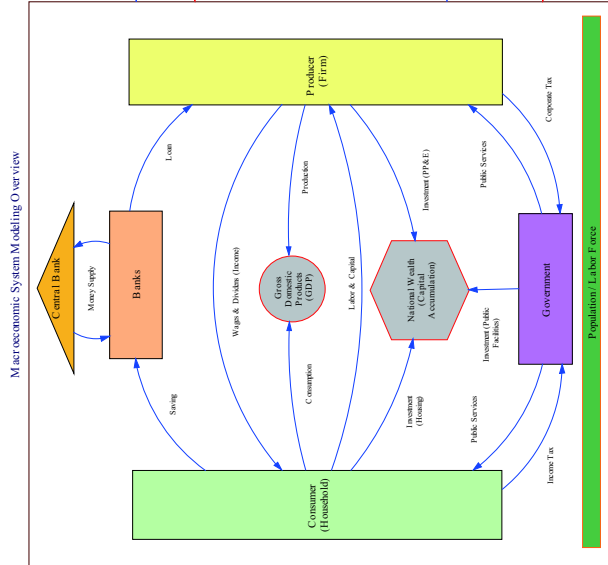

Macroeconomic System Modeling Overview

Table	Overview
Population	Population, Labor Force
Money	Money Supply, Currency, Exchange Rate
GDP	GDP, Income, Price & Wage
Producer	Producer, Wages & Dividends (Income)
Consumer	Consumer, Consumption
Government	Government, Corporate Tax, Income Tax
Banks	Banks, Loans, Savings
Central Bank	Central Bank, Money Supply
National Wealth	National Wealth, Investment (PP&E), Investment (Public Facilities)
Balance of Payments	Balance of Payments, Exports, Imports
GDP	GDP, Income, Price & Wage
Factor Policy	Factor Policy, Investment (Housing), Investment (Public Facilities)
Monetary Policy	Monetary Policy, Money Supply
Fiscal Policy	Fiscal Policy, Corporate Tax, Income Tax
Economic Simulation	Economic Simulation, GDP, Income, Price & Wage

Figure 15: Model Overview

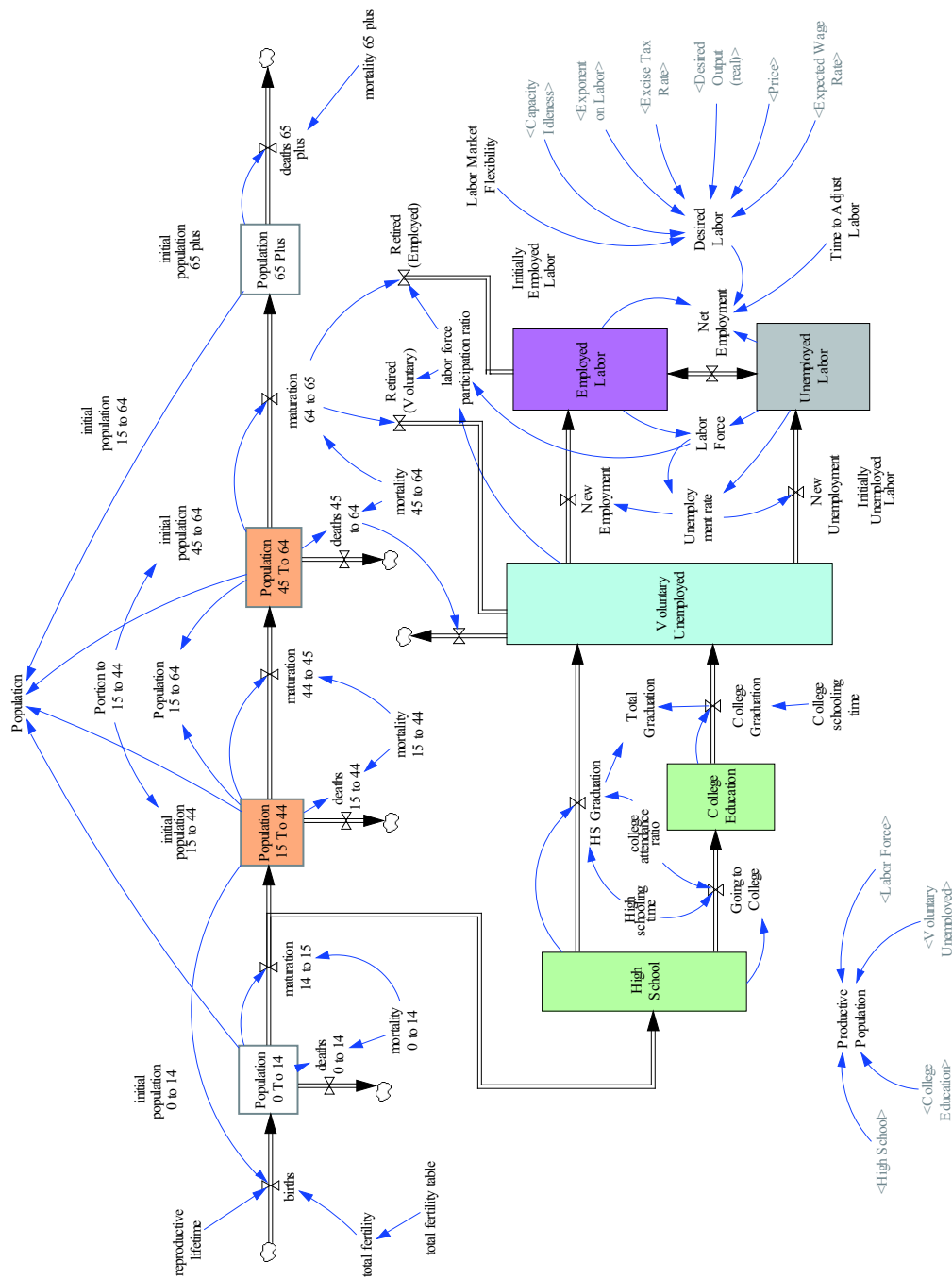

Figure 16: Population and Labor Force

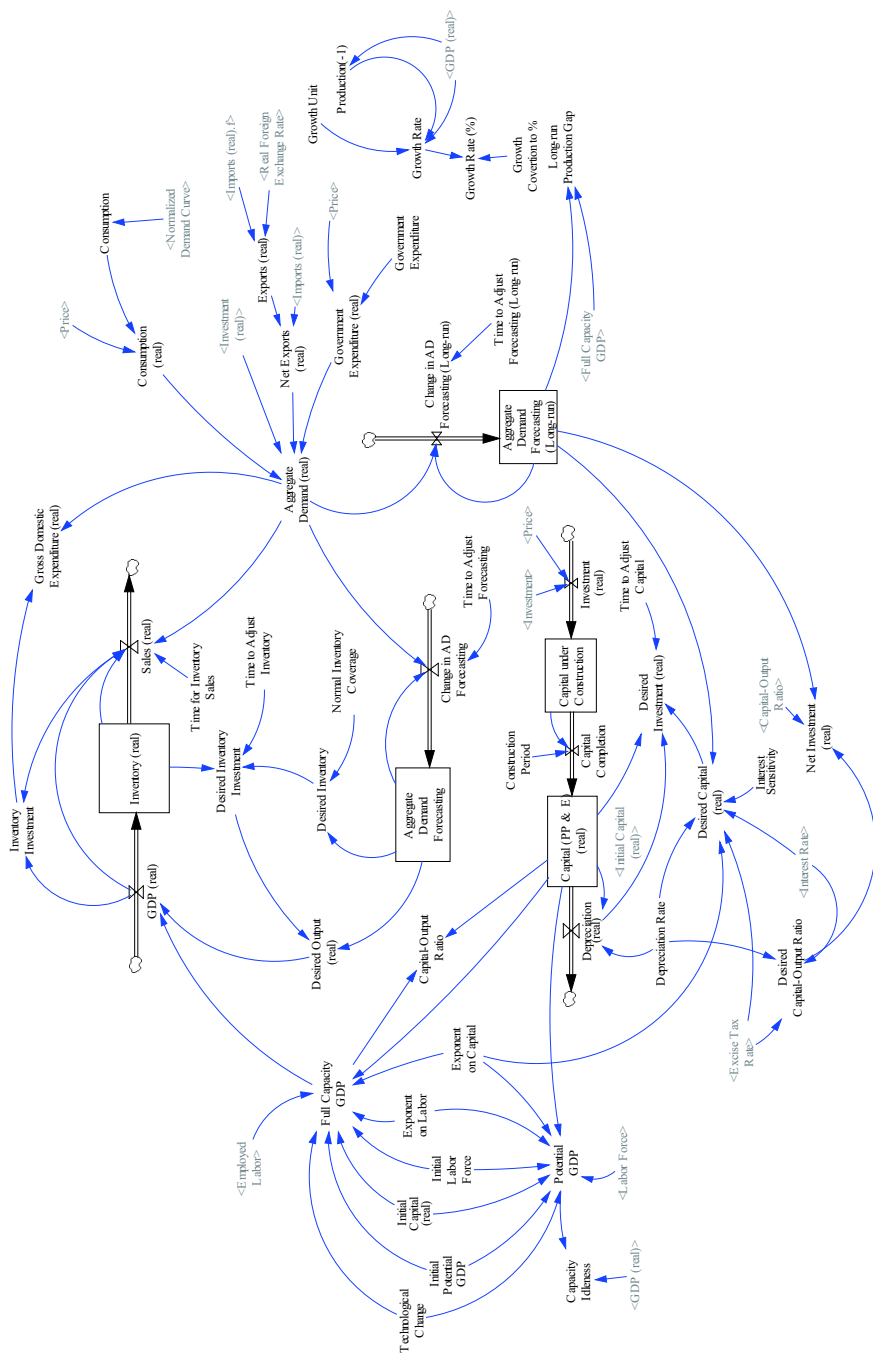

Figure 17: GDP Determination

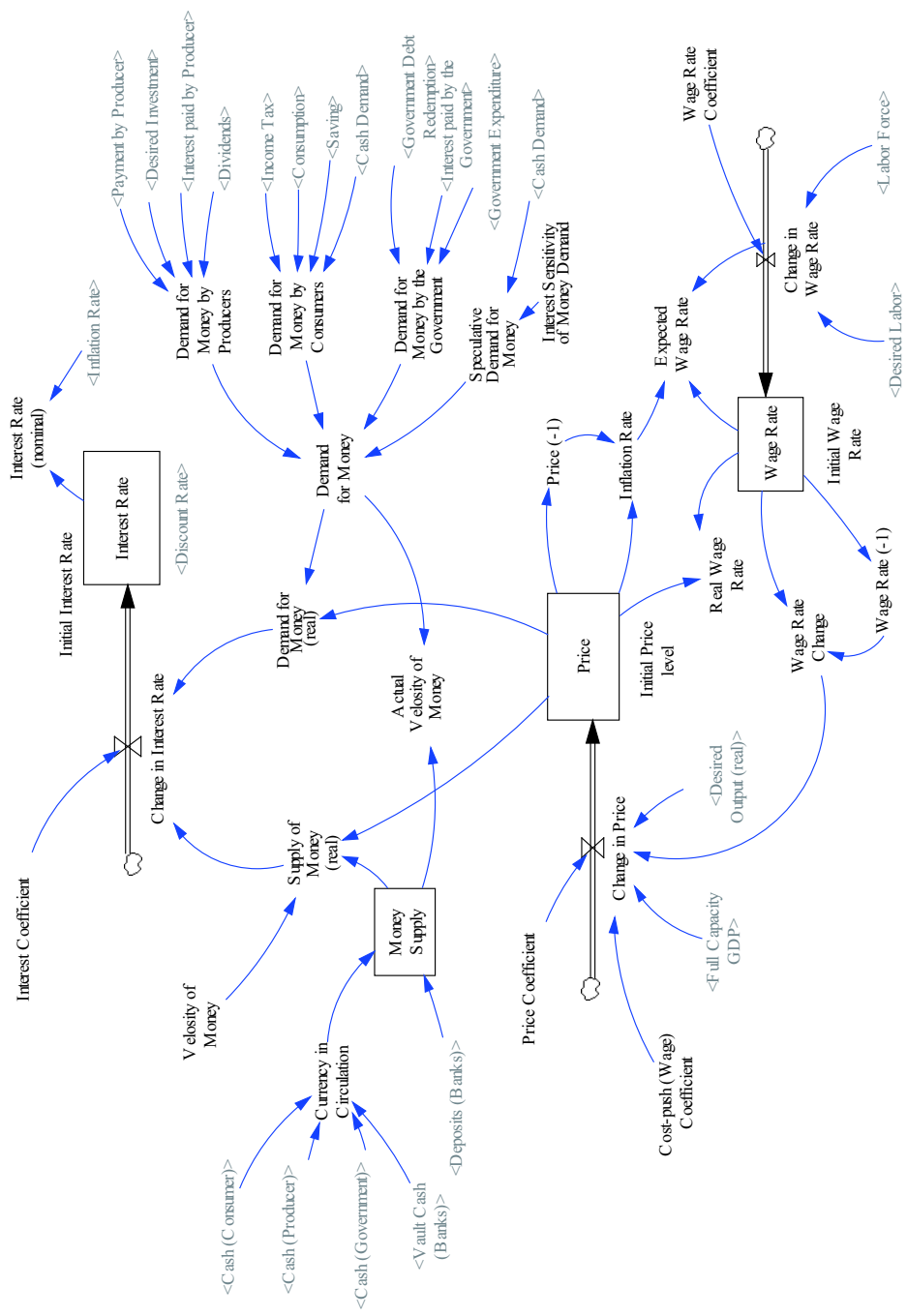

Figure 18: Interest Rate, Price and Wage Rate

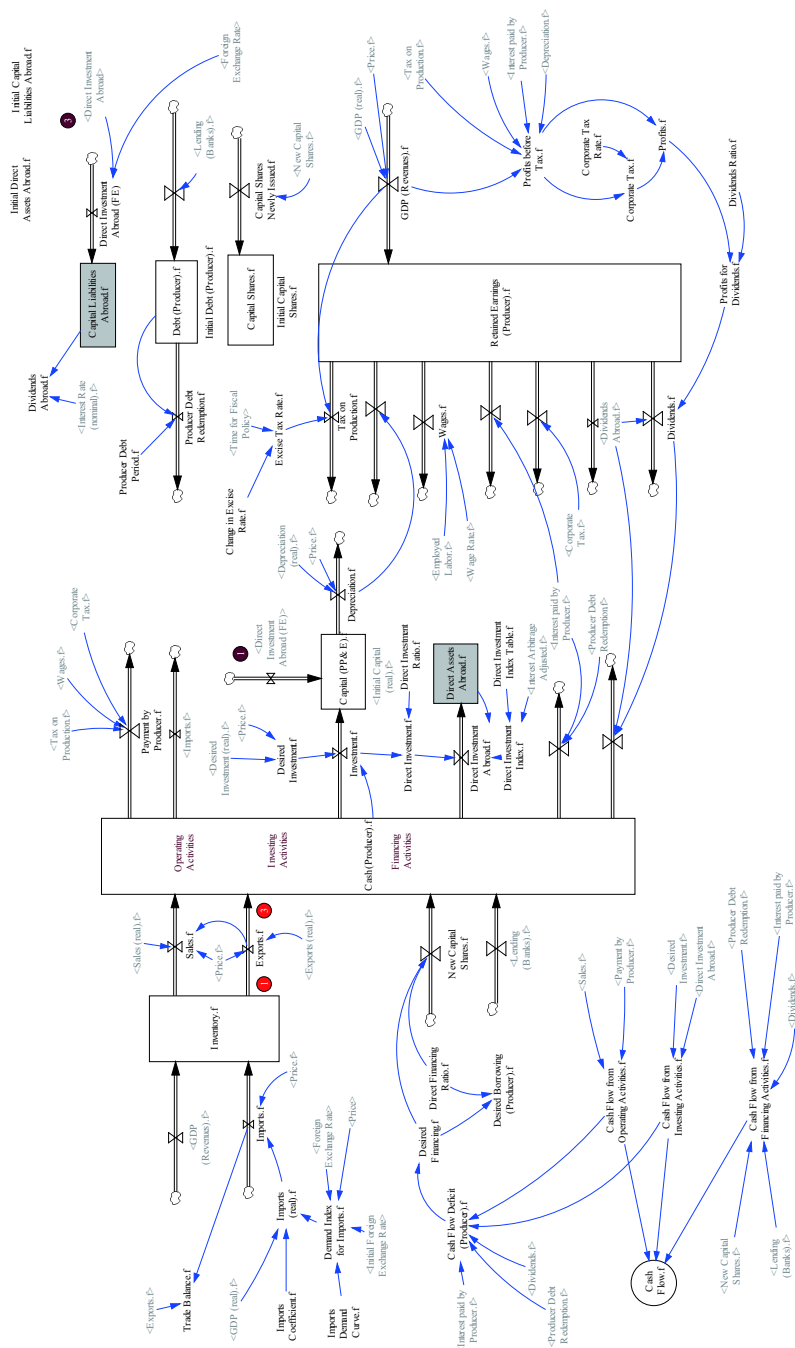

Figure 19: Transactions of Producers

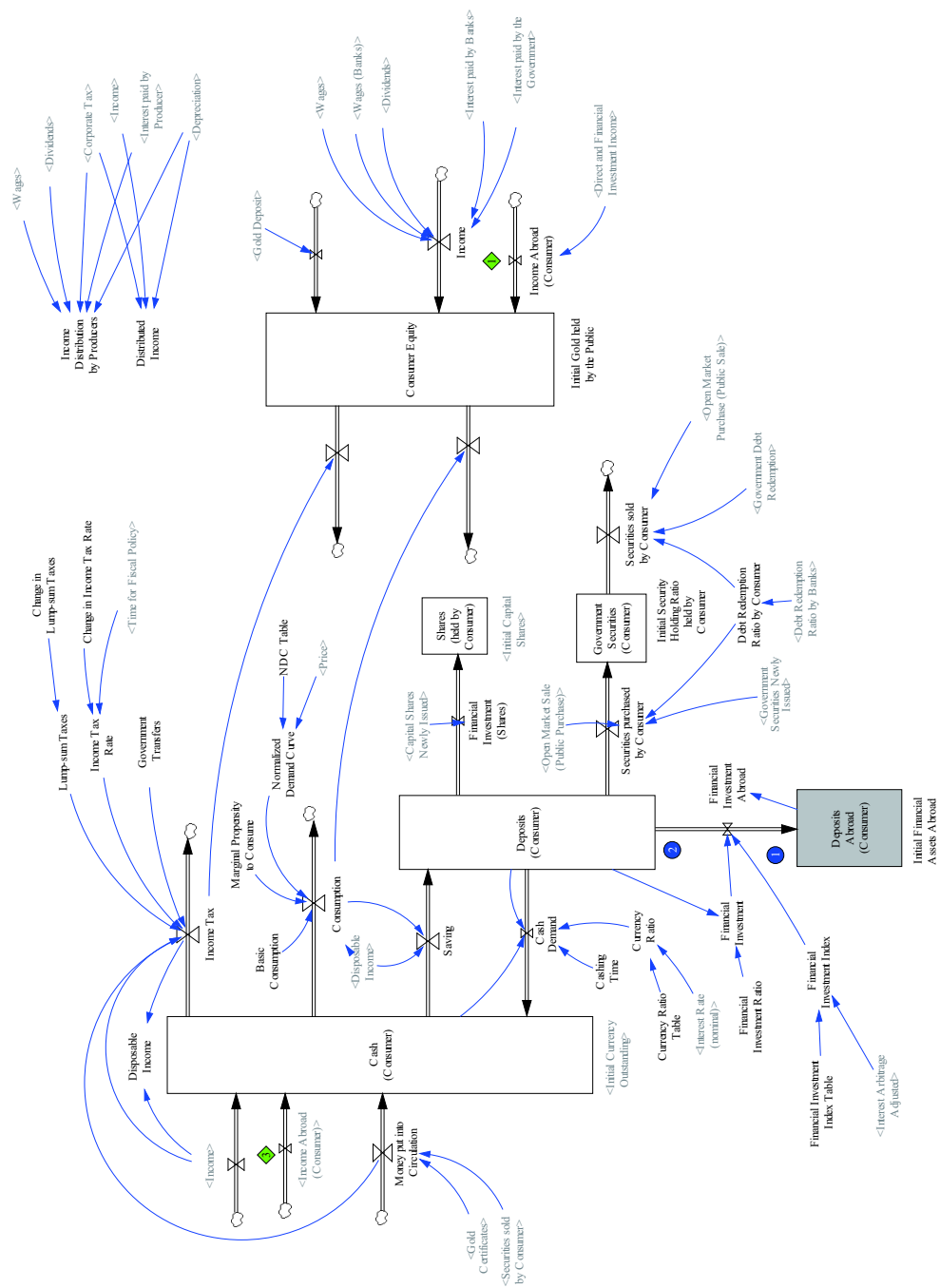

Figure 20: Transactions of Consumers

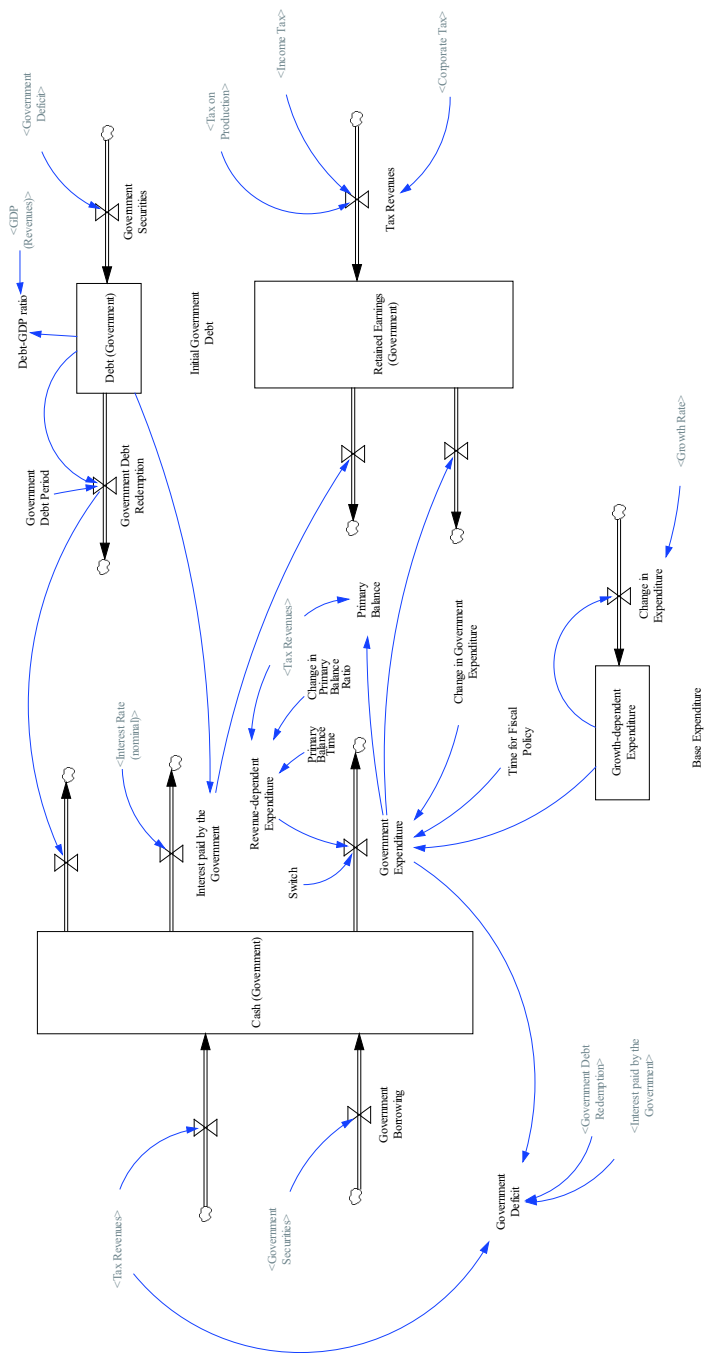

Figure 21: Transactions of Government

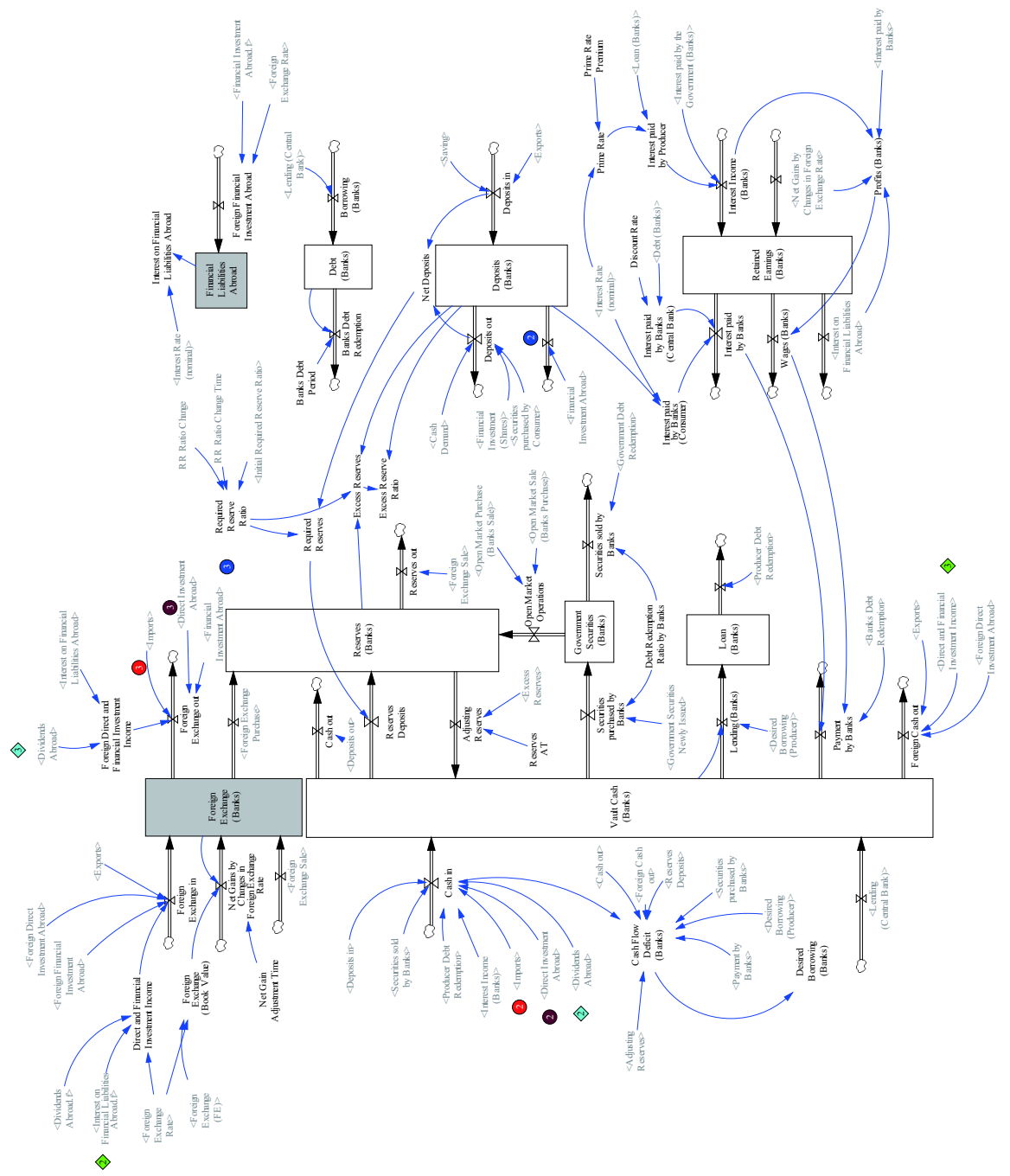

Figure 22: Transactions of Banks

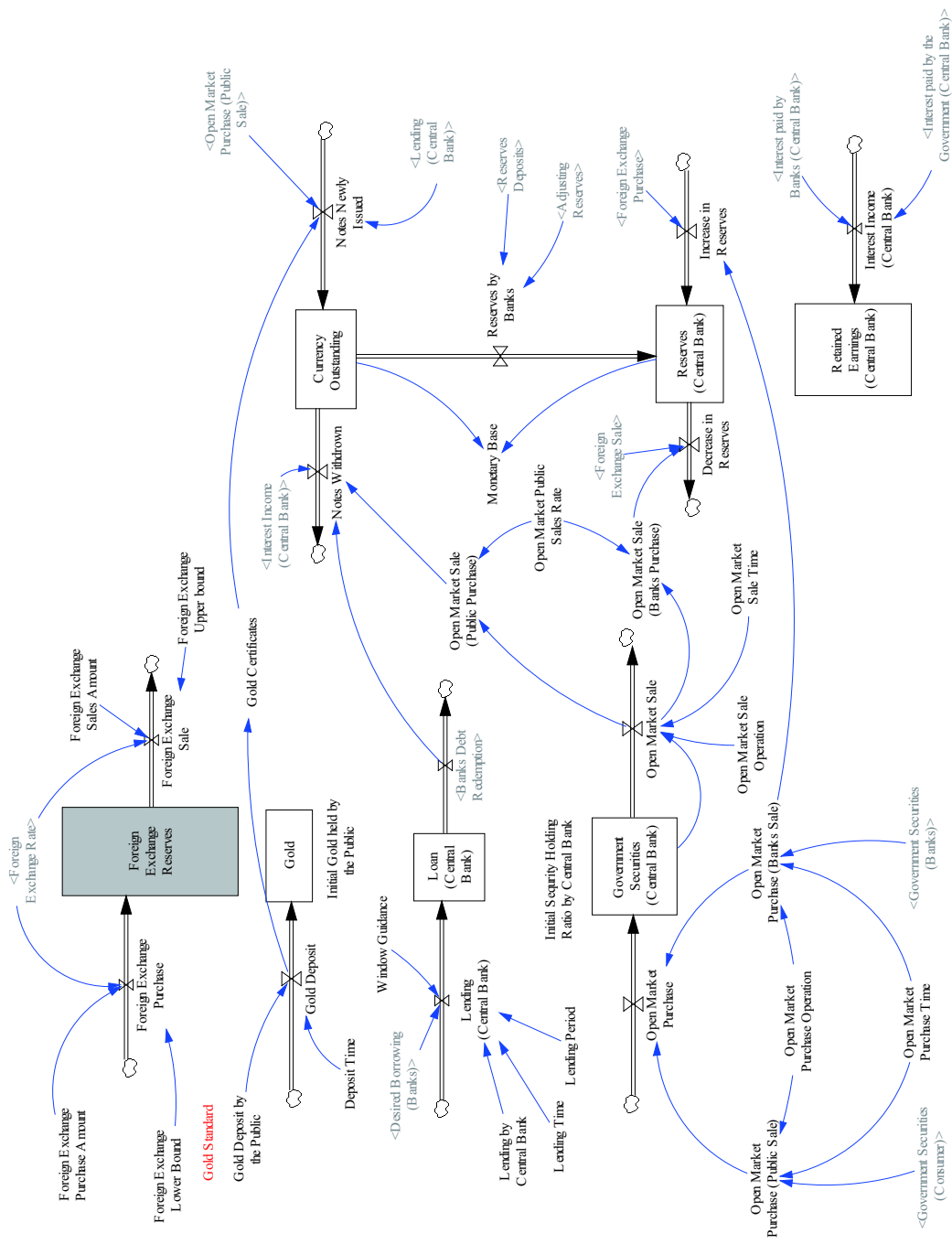

Figure 23: Transactions of Central Bank

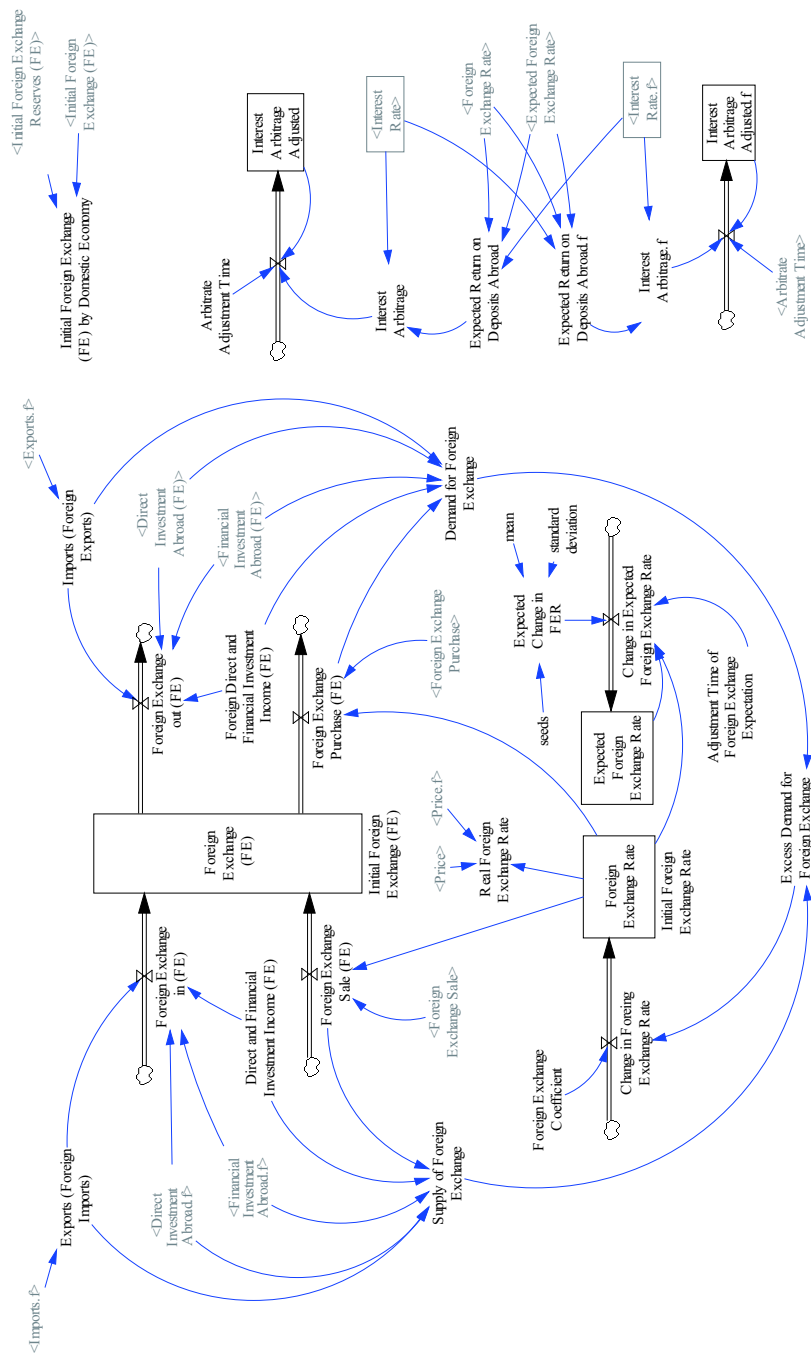

Figure 24: Foreign Exchange Market

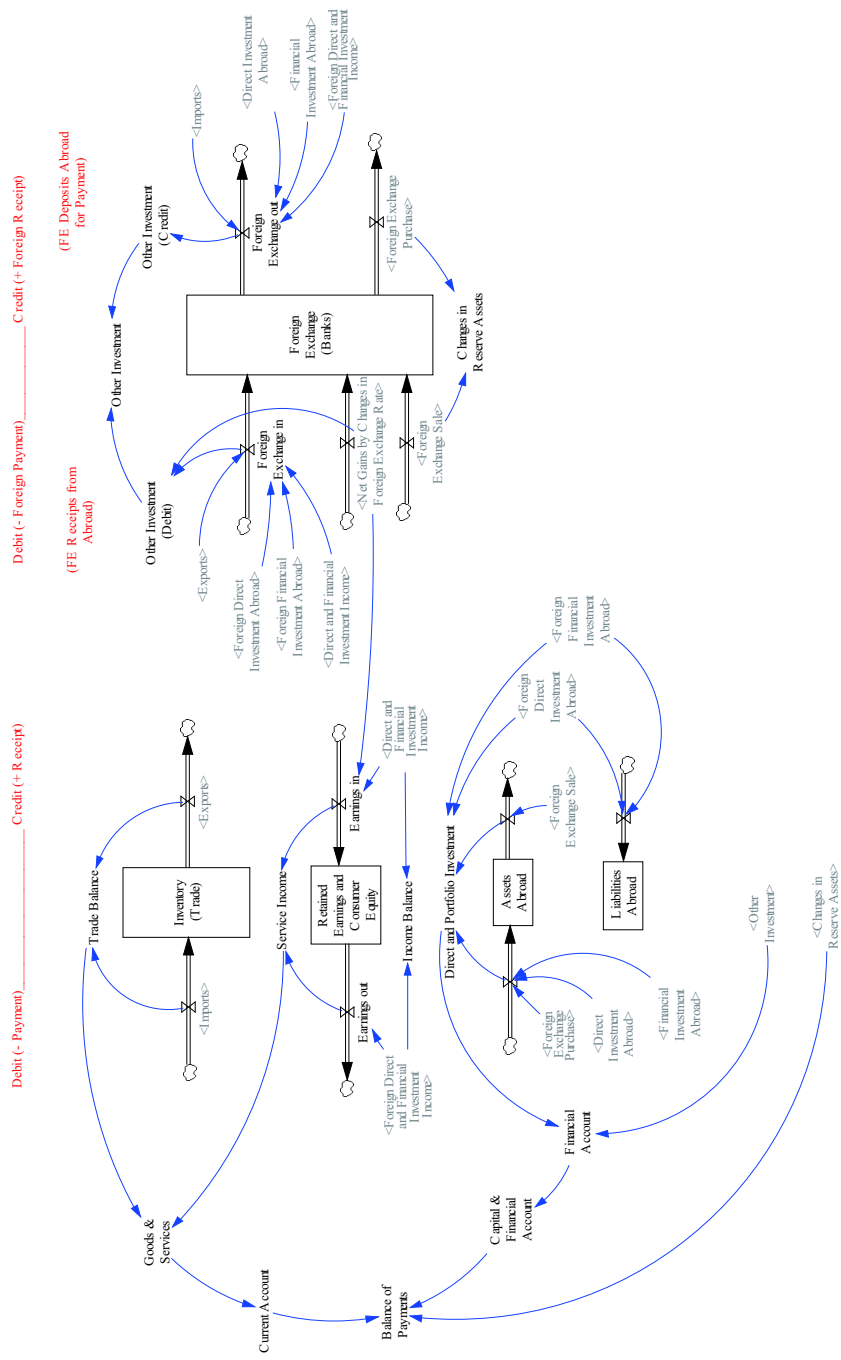

Figure 25: Balance of Payment

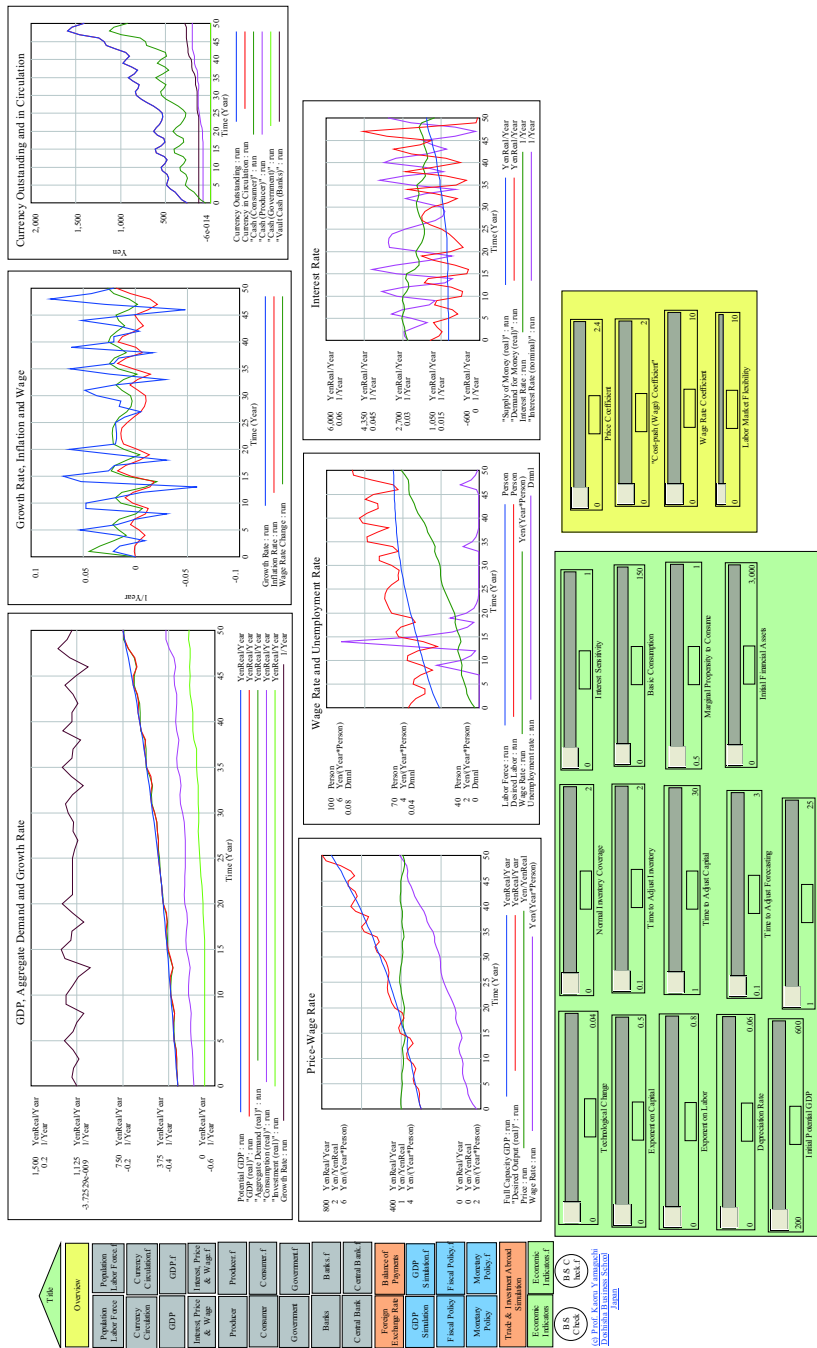

Figure 26: Simulation Panel of GDP

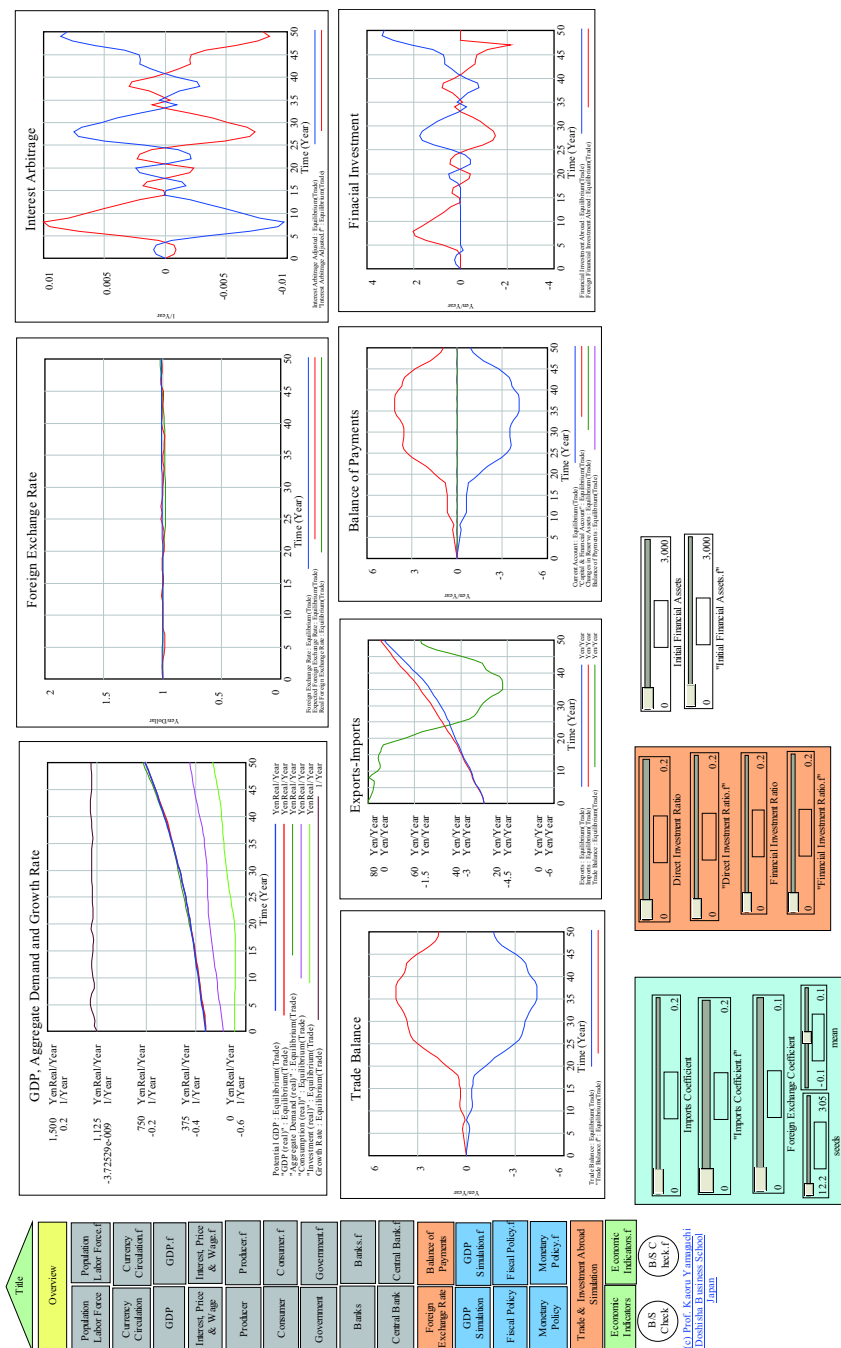

Figure 27: Simulation Panel of Trade and Investment Abroad

References

- [1] Richard A. Werner. *new paradigm in macroeconomics: solving the riddle of japanese macroeconomic performance*. Palgrave Macmillan, New York, 2005.
- [2] Kaoru Yamaguchi. *Beyond Walras, Keynes and Marx – Synthesis in Economic Theory Toward a New Social Design*. Peter Lang Publishing, Inc., New York, 1988.
- [3] Kaoru Yamaguchi. Principle of Accounting System Dynamics – Modeling Corporate Financial Statements –. In *Proceedings of the 21st International Conference of the System Dynamics Society*, New York, 2003. System Dynamics Society.
- [4] Kaoru Yamaguchi. Money Supply and Creation of Deposits : SD Macroeconomic Modeling (1). In *Proceedings of the 22nd International Conference of the System Dynamics Society*, Oxford, England, 2004. The System Dynamics Society.
- [5] Kaoru Yamaguchi. Aggregate Demand Equilibria and Price Flexibility : SD Macroeconomic Modeling (2). In *Proceedings of the 23rd International Conference of the System Dynamics Society*, Boston, USA, 2005. The System Dynamics Society.
- [6] Kaoru Yamaguchi. Integration of Real and Monetary Sectors with Labor Market: SD Macroeconomic Modeling (3). In *Proceedings of the 24th International Conference of the System Dynamics Society*, Nijmegen, The Netherlands, 2006. The System Dynamics Society.
- [7] Kaoru Yamaguchi. Balance of Payments and Foreign Exchange Dynamics: SD Macroeconomic Modeling (4). In *Proceedings of the 25th International Conference of the System Dynamics Society*, Boston, USA, 2007. The System Dynamics Society.